**NK8/16-TV-XL**

Needle roller bearing

Schaeffler ID:
0507532660000

Needle roller bearings NK, light series

X-life

Technical information

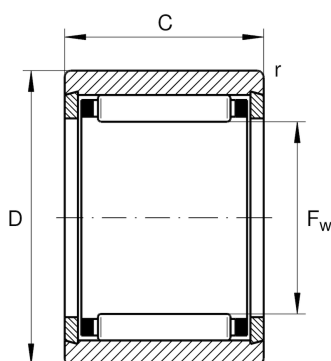
**Main Dimensions & Performance Data**

F_w	8 mm	Under roller diameter
D	15 mm	Outside diameter
C	16 mm	Width, outer ring
C_r	5,800 N	Basic dynamic load rating, radial
C_{0r}	5,800 N	Basic static load rating, radial
C_{ur}	990 N	Fatigue load limit, radial
n_G	32,500 1/min	Limiting speed
n_{gr}	36,500 1/min	Reference speed
	11.7 g	Weight

Additional information

r_{min}	0.3 mm	Minimum chamfer dimension
	G8X15X3	Sealing ring
	SD8X15X3	Sealing ring 2

Temperature range

T_{min}	-20 °C	Operating temperature min.
T_{max}	120 °C	Operating temperature max.